

# Description of a Fetch SHIP

(slides)

Ivan Sutherland  
12 October 2006

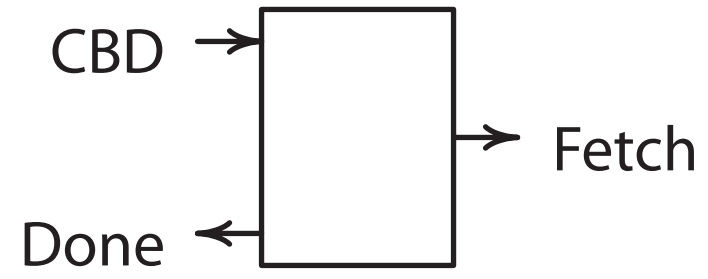

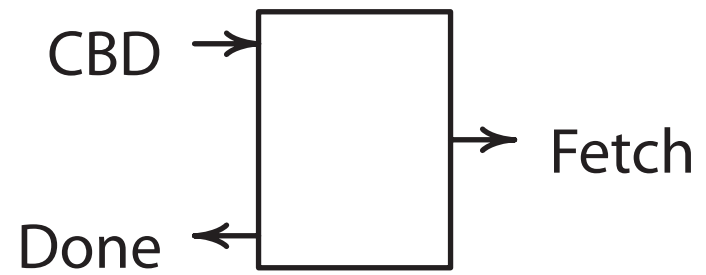
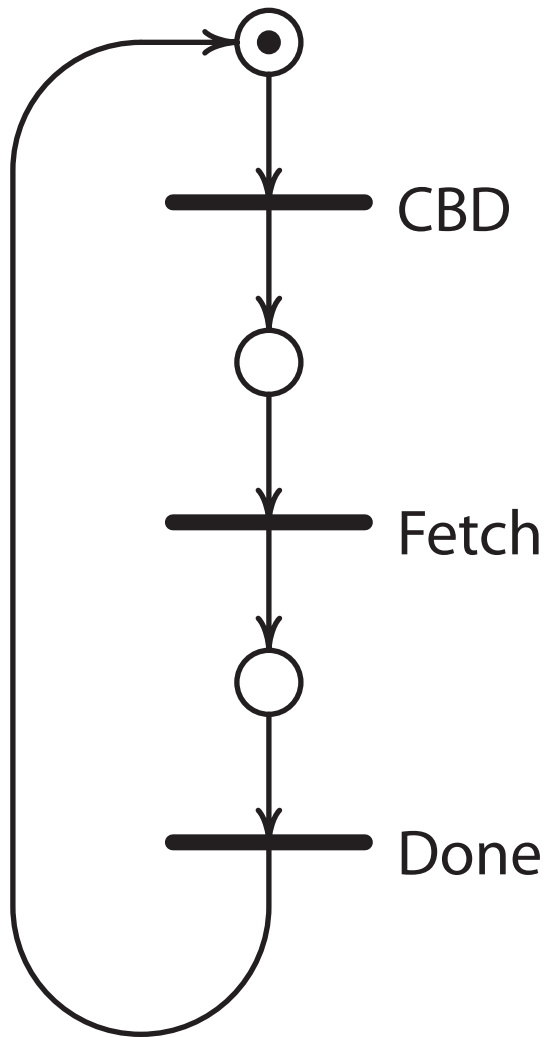

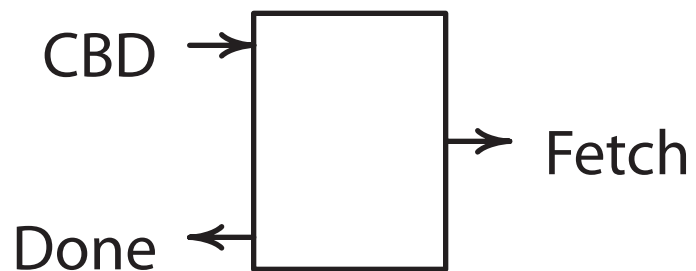
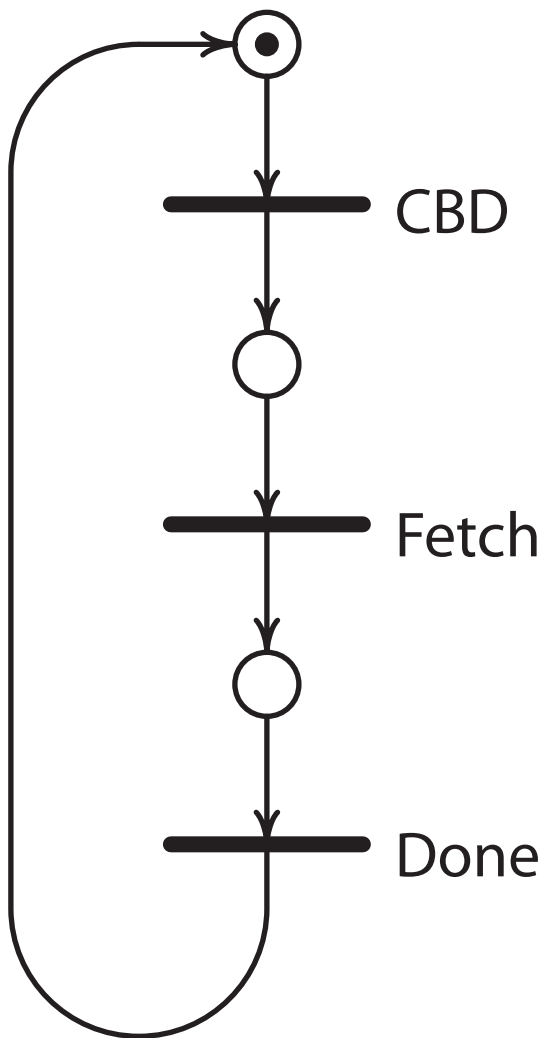

```

fetchShip =
|CBD => ;; Fetch
      ;; token !-> Done

```

*Switch fabric actions in red italics*

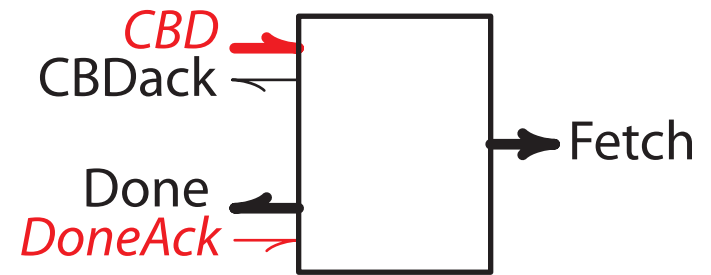

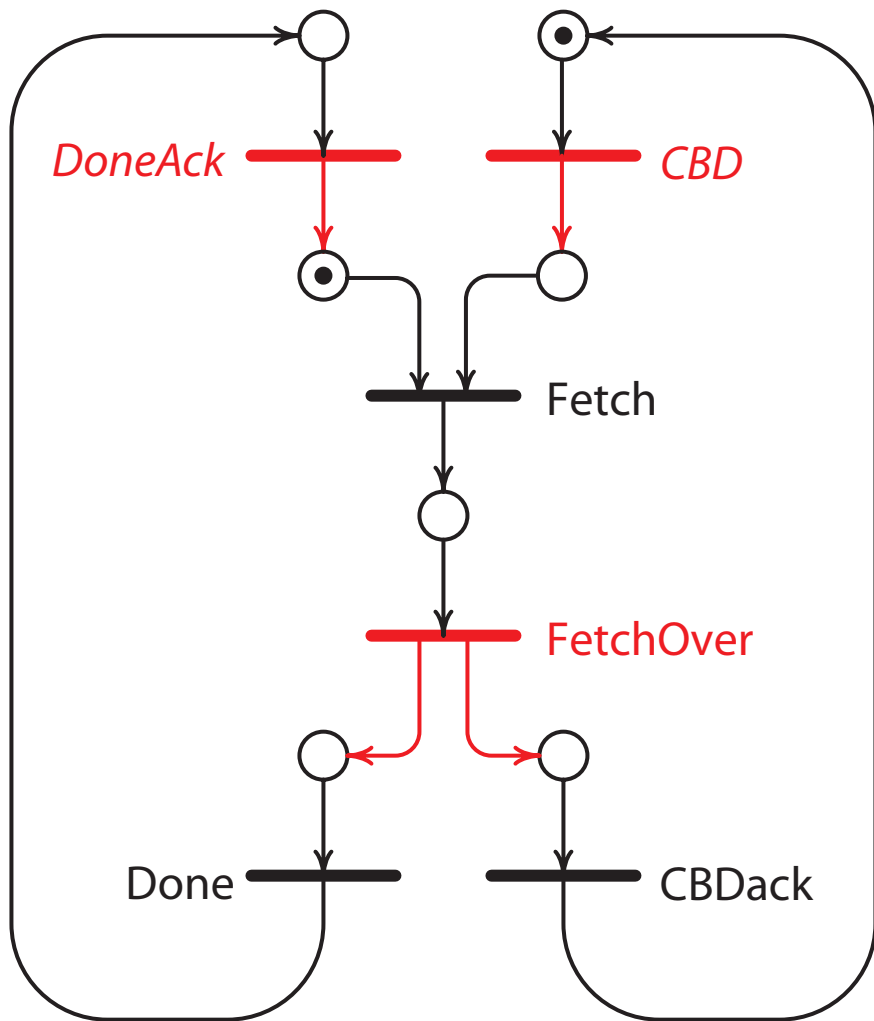

*Switch fabric actions in red italics*

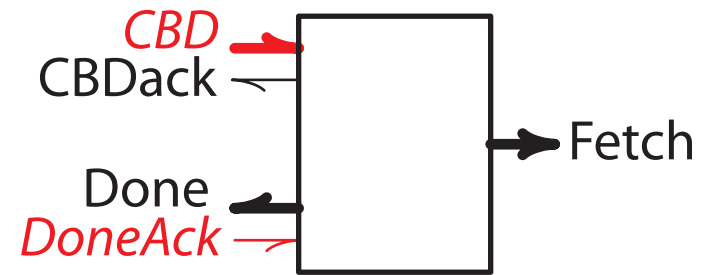

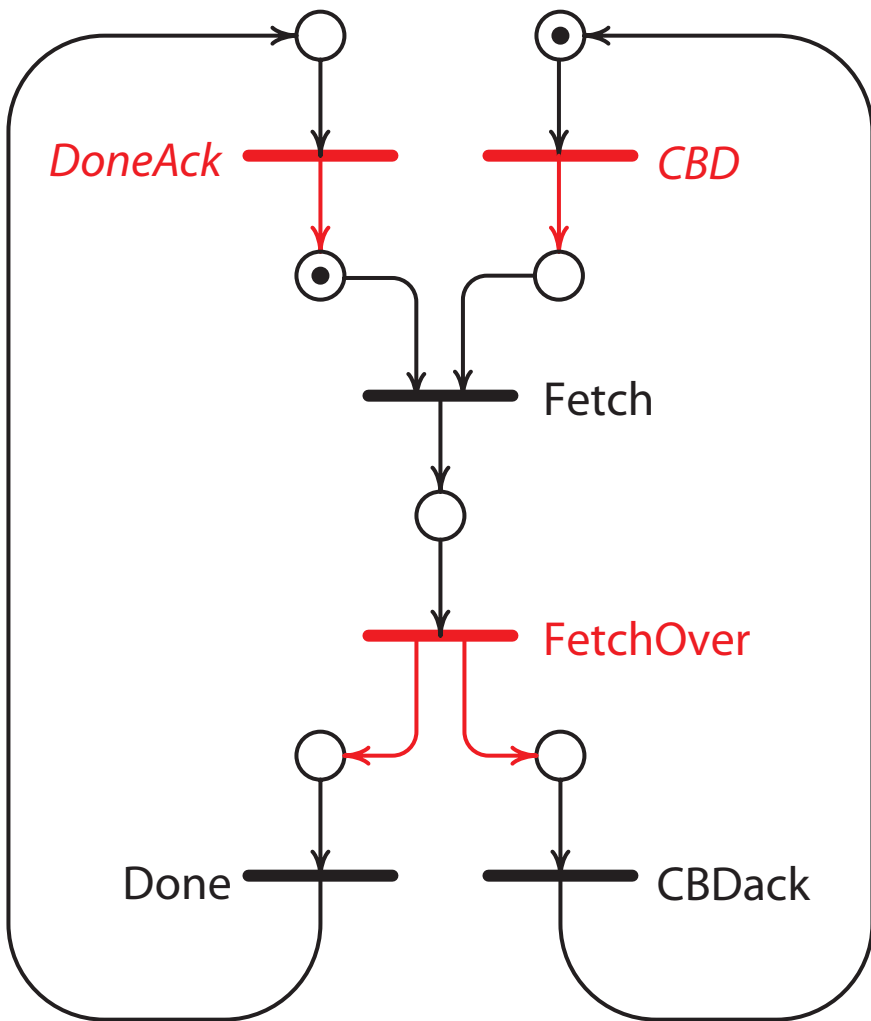

*Switch fabric actions in red italics*

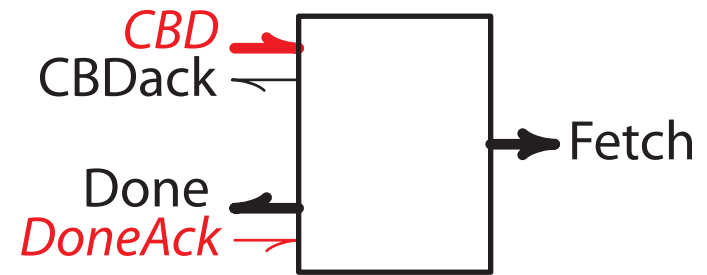

```

detailFetchShip =
;; CBD ?-> x
;; repeat
;; x !-> Fetch
;;
|| token!->Done    ;; DoneAck?->_
|| token!->CDBack ;; CBD?->x

```

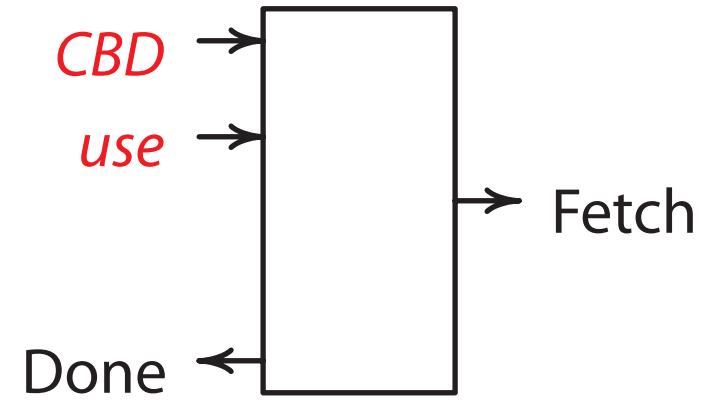

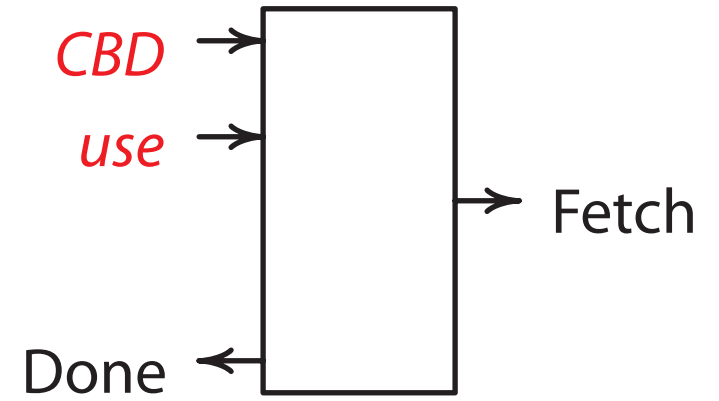
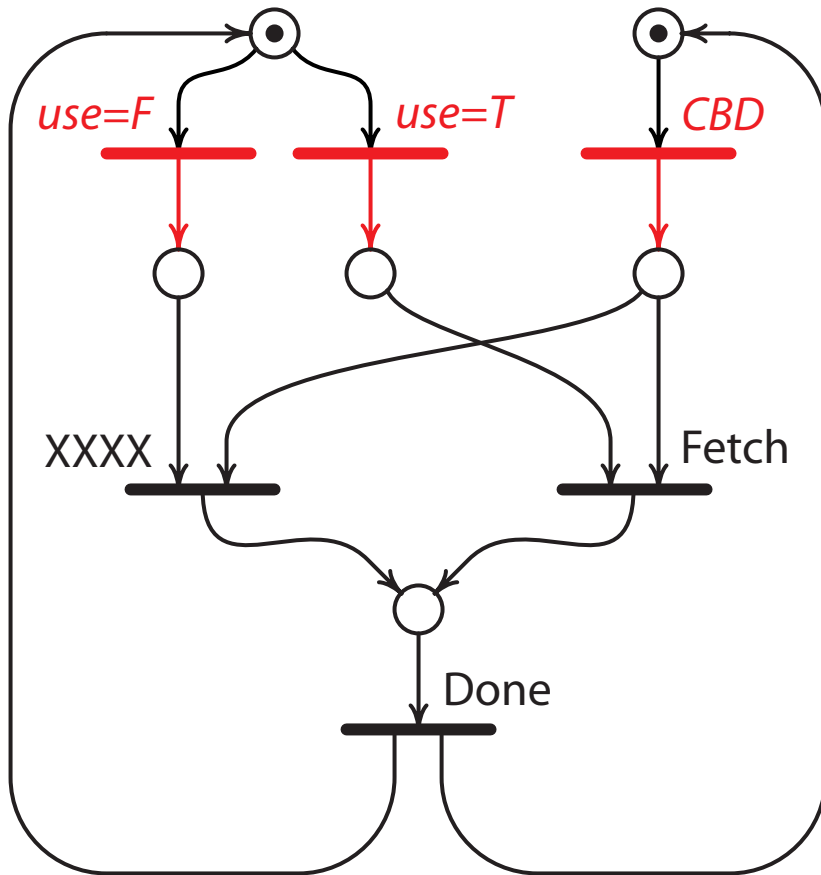

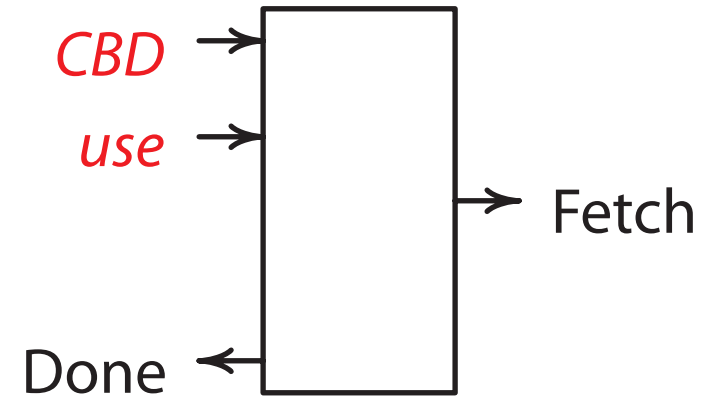
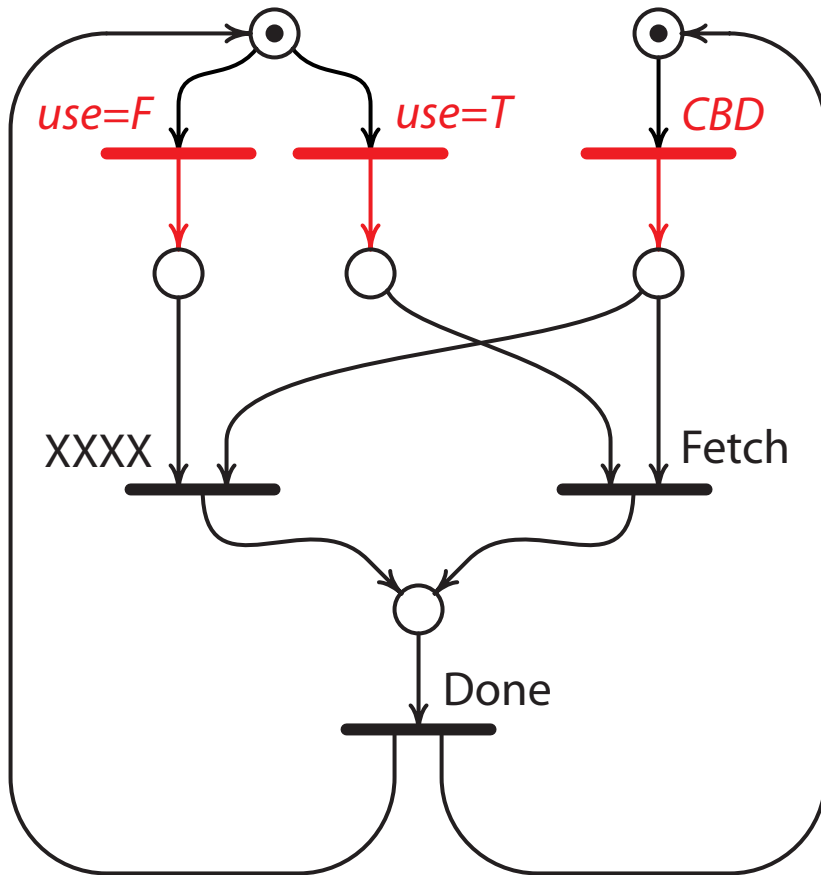

```

conditionalFetchShip =
repeat
  ;; | (CBD, use=T) => CBD !-> Fetch
     | (CBD, use=F) => DrinkFostersBeer
  ;; token !-> Done

```

